

Technical data sheet

Reduction, PG thread

Item number: 2089114

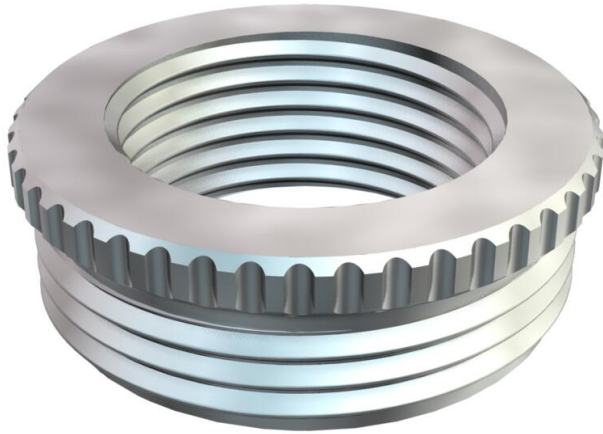

Reduction (Part H) to DIN 46320, with Pg thread to DIN 40430, as a transition from a PG thread hole to a smaller cable gland.

* Prices according to DEL notation.



CuZn
37 Brass

N Nickel-plated

Master data

Item number	2089114
Type	167 R MS PG13-9
Description 1	Reduction
Manufacturer	OBO
Dimension	PG13,5-PG9
Material	Brass
Surface	Nickel-plated
Surface standard	
Smallest sales unit	50
Unit of quantity	Units
Weight	1,12 kg
Weight unit	kg/100 pairs
CO2 Footprint (GWP) Cradle-to-Gate	0,0279 kg CO2e / 1 Piece

Technical data sheet

Reduction, PG thread

Item number: 2089114



Dimensions

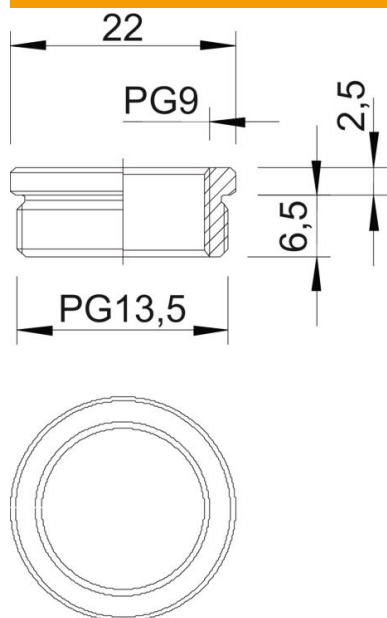

Dimension D	22 mm
Dimension L1	6,5 mm
Dimension L2	2,5 mm

Technical specifications

explosion-proof	no
Thread type: External thread	Pg
Thread type: Internal thread	Pg
Thread length	6,5 mm
Thread dimension, PG, external	13,5
Thread dimension, PG, internal	7
Nickel-plated	yes