

# Technical data sheet

## ISO base clip

Item number: 2130408



ISO base clip 36.5–40 mm



PS Polystyrene

### Master data

Item number	2130408
Type	2960 40 M6 LGR
Description 1	ISO base clip
Manufacturer	OBO
Dimension	36,5-40mm
Colour	Light grey; RAL 7035
Material	Polystyrene
Smallest sales unit	20
Unit of quantity	Units
Weight	3,017 kg
Weight unit	kg/100 pairs
CO2 Footprint (GWP) Cradle-to-Gate	0,127 kg CO2e / 1 Piece

# Technical data sheet

## ISO base clip

Item number: 2130408



### Dimensions

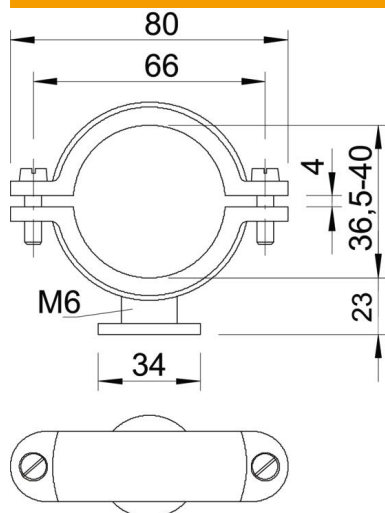

Dimension A	80 mm
Dimension B	66 mm
Dimension d	34 mm
Dimension H	23 mm
Dimension x	4 mm

### Technical specifications

Number of cables/pipes	1
Version for	Closed
Fastening type	Screw hole
Suitable in fire protection area	no
Thread	M6
Size	Pg 9
Halogen-free	yes
Plastic-covered	no
Bolt	M5 x 18
Clamping range D, max.	40 mm
Clamping range D, min.	36,5 mm
UV-resistant	no